

QUALITY CONTROL:

- D** Falls Sie Reklamationen haben, oder Sie unzufrieden mit Ihrem RONAL Produkt sind, beschreiben Sie bitte unten auf diesem Blatt den Produktfehler und übergeben Sie dieses Dokument Ihrem Verkäufer, oder direkt der Firma RONAL. Diese Information hilft uns, die Qualität von unseren Produkten weiter zu verbessern.
- GB** In case of a complaint or Your dissatisfaction with the RONAL product, please describe the defect below and pass this document to Your vendor, or directly to the RONAL company. This information will help us in the next increase of the quality of our products.
- F** En cas de réclamations lors de la livraison ou l'installation de votre paroi de douche RONAL, veuillez, s'il vous plaît, noter vos remarques au bas de la feuille et transmettre les informations à votre revendeur. Elles nous permettrons d'améliorer notre qualité et par la même notre service.
- CZ** V případě reklamace, či Vaší nespokojenosti s výrobkem RONAL popište prosím ve spodní části tohoto listu závadu a dokument prosím odevzdejte Vašemu prodejci nebo přímo firmě RONAL. Tato informace nám pomůže v dalším zvýšení kvality našich výrobků.
- PL** Reklamacje , oraz inne niezgoności związane z produktem RONAL prosimy przekazywać sprzedawcy na załącznym druku.
- SK** V prípade reklamácie, alebo Vašej nespokojnosti s výrobkom RONAL, popište prosím v spodnej časti tohto listu závadu a dokument prosím odovzdajte Vašemu prodejci, alebo priamo firme RONAL. Táto informácia nám pomôže v ďalšom zvýšení kvality našich výrobkov.
- H** Abban az esetben ha reklamációja vagy panasza van az Ön által vásárolt RONAL termékkel, úgy azt írja meg a lap alján található helyre és adja át a kereskedőjének, vagy küldje el közvetlenül a RONAL cégnek! Ez az információ segít nekünk termékeink minőségének javításában.
- E** En caso de reclamaciones ó si no está satisfecho con su producto RONAL, por favor describan en la parte inferior de esta hoja el fallo del producto y entreguen este documento a su vendedor ó directamente a la empresa RONAL. Esta información nos ayuda a seguir mejorando la calidad de nuestros productos.

.....

.....

.....

.....

.....

.....

.....

.....

.....

TOPR

- | | | |
|-----------|----------------------------|--|
| D | MONTAGEANLEITUNG: | RUNDDUSCHE MIT ZWEI SCHIEBETÜREN |
| GB | INSTALLATION INSTRUCTIONS: | ROUND ENCLOSURE WITH 2 SLIDING DOORS |
| F | NOTICE DE MONTAGE: | PORTE COULISSANTE QUART DE ROND |
| CZ | NÁVOD K MONTÁŽI: | ČTVRTKRUHOVÁ ZÁSTĚNA SE DVĚMA POSUVNÝMI DVEŘMI |
| PL | INSTRUKCJA MONTAŻU: | KABINA PÓŁOKRĄGŁA |
| SK | NÁVOD NA MONTÁŽ: | ŠTVRTKRUHOVÁ ZÁSTĚNA S DVOMA POSUVNÝMI DVERAMI |
| H | SZERELÉSI ÚTMUTATÓ: | ÍVES KABIN KÉT TOLÓAJTÓVAL |
| E | INSTRUCCIONES DE MONTAJE: | SEMICIRCULAR 2 HOJAS CORREDERAS |

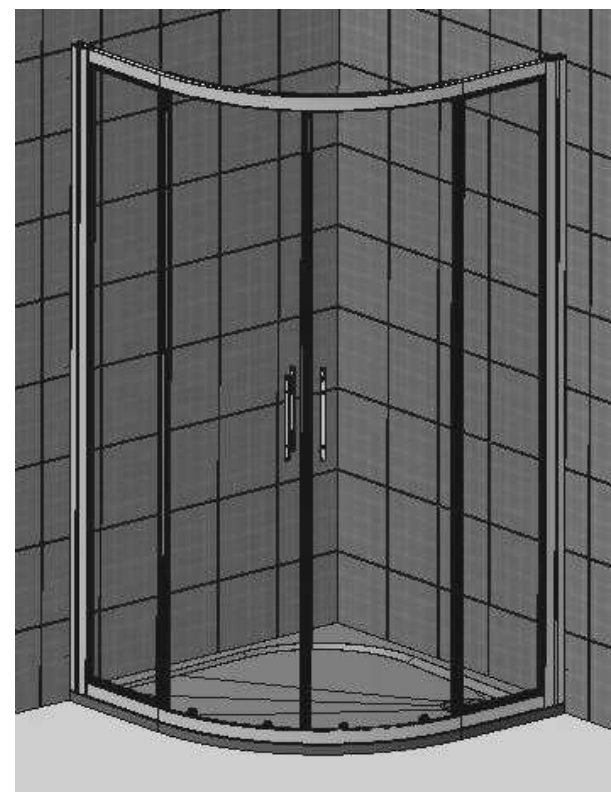

RONAL®

Benötigtes Werkzeug:
 Necessary tools:
 Outil Nécessaire:
 Nářadí potřebné pro montáž:

Potrzebne narzędzia:
 Potrebne náradie:
 Szükséges szerszámok:
 Herramientas necesarias:



1x

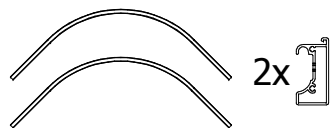
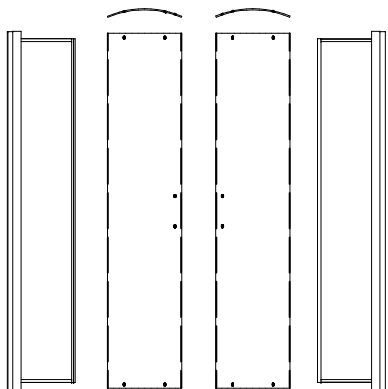
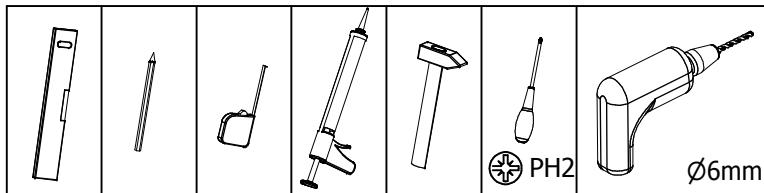

2x

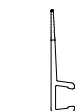











2x82111

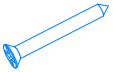

42356 L+R

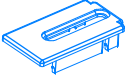
Zubehör:
 Equipment:
 Accessoires:
 Příslušenství:

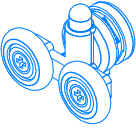
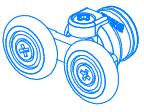
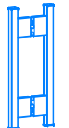
Dodatki:
 Príslušenstvo:
 Alkatrészek:
 Accesorios:

 1x11221	 6x11295	 6x14118 4,2x32mm	 6x16000 Ø6mm	 8x14016 3,5x25 mm
 2x14196 3,5x13 mm	 2x81230	 2x81330	 4xMT8002	 4xMT8004
 2xMT8006	 8x81393			

2.

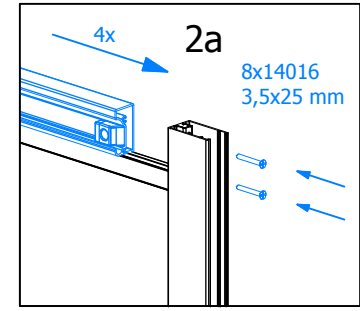
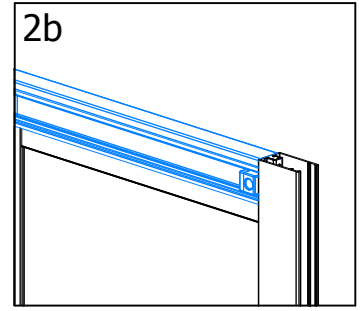
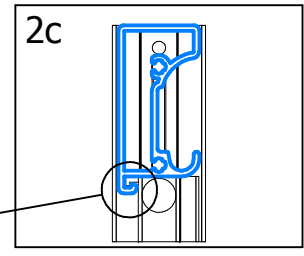
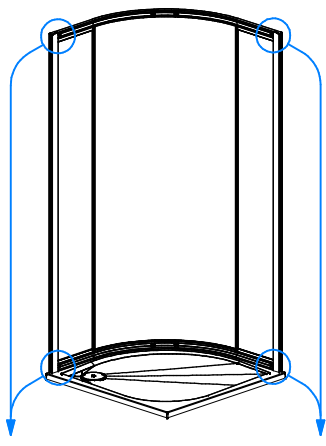
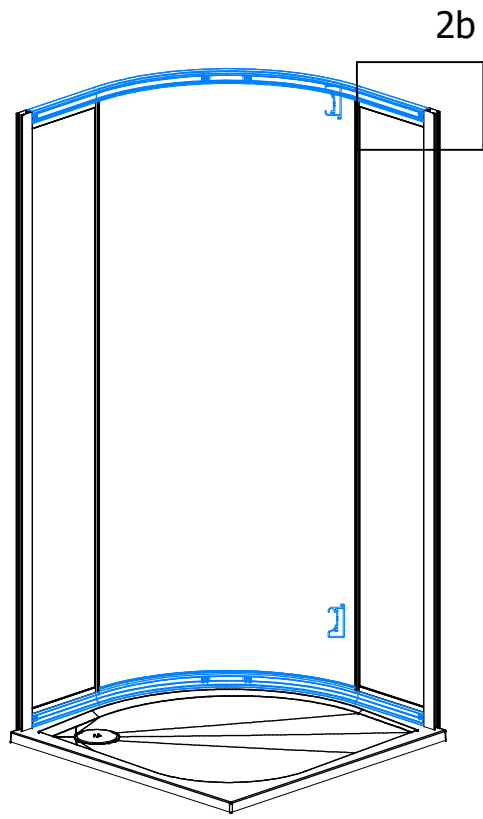

2b

4x

2a

8x14016
3,5x25 mm

2b

2c

A: MT8004(4x)+81393(4x)

B: MT8002(4x)+81393(4x)

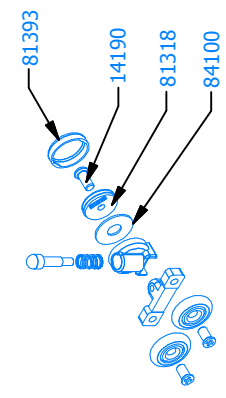
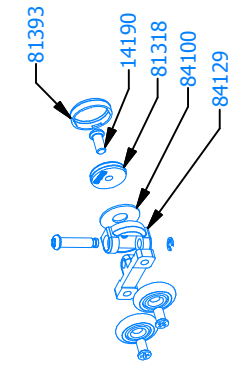

MT8006 (2x)

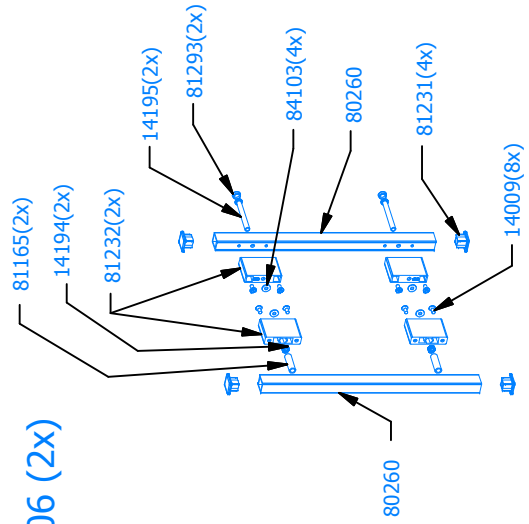

11.

10a

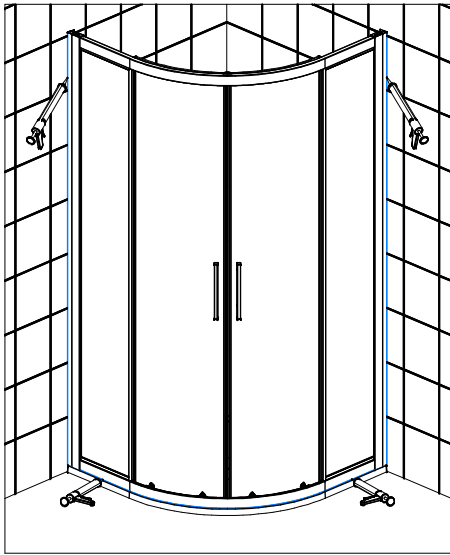

10b

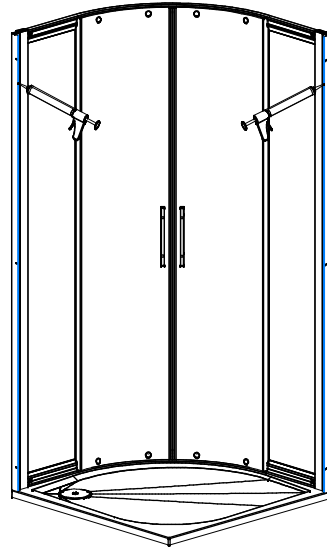

10c

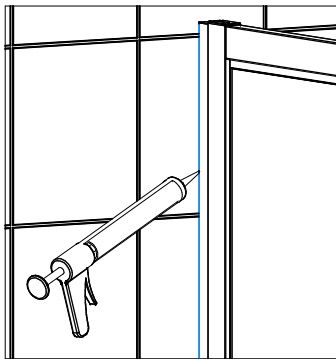

10d

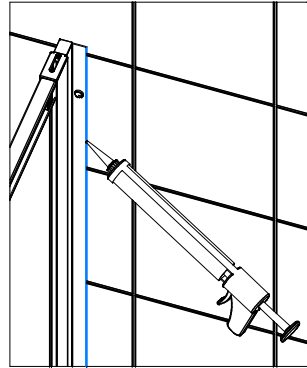

Achtung! Nur Sanitär-Silikon - bakterizid und fungizid eingestellt verwenden.

Caution! Use only bactericidal and fungicide sanitary silicone.

Attention! N'utiliser que du silicone sanitaire bactéricide et fongicide.

Pozor! Používejte pouze baktericidní a fungicidní sanitární silikon.

Uwaga! Stosować tylko silikon sanitarny - bakterio i grzybobójczy.

Pozor! Užívajte pouze baktericidný a fungicidný sanitárny silikon.

Figyelem! Csak szaniter sziloplaszt - baktérium és gombamentes - használatra engedett.

Cuidado! Utilizar solamente silicona sanitaria bactericida y fungicida.

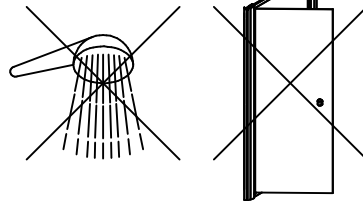

10.

(D) Verstellbereich für Montage auf Duschwanne oder bodenebenen.

(GB) Presetting range for assamblage on the shower tray or on the pavage.

(F) Plage de réglage pour une pose sur receveur ou à l'italienne.

(CZ) Přestavné míry pro montáž na vaničku nebo na dlažbu.

(PL) Zakres regulacji do montażu na brodziku lub bezpośrednio na posadzce.

(SK) Prestavná šírka pre montáž na vaničku alebo podlahu.

(H) Állíthatóság zuhanytálcára vagy padlóra való építésnél.

(E) Zona de ajuste en platos de ducha o a ras de suelo.

3a

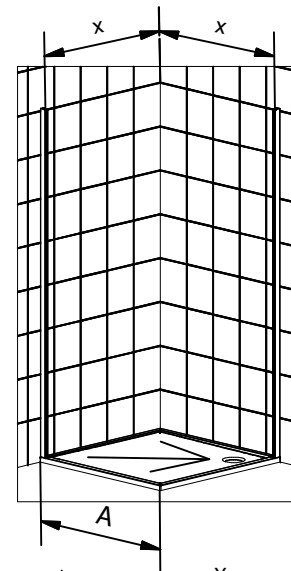

3b

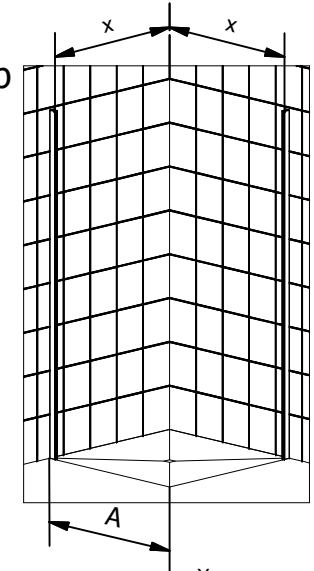

3c

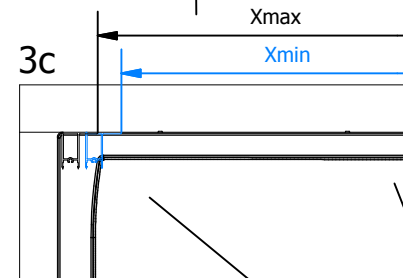

3d

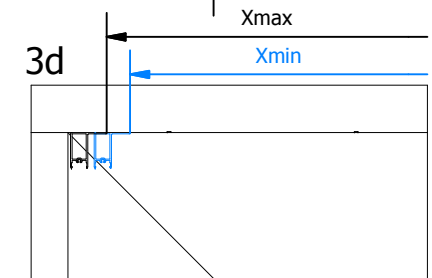

A	X min	X max
800	734	759
900	834	859
1000	934	959

3.

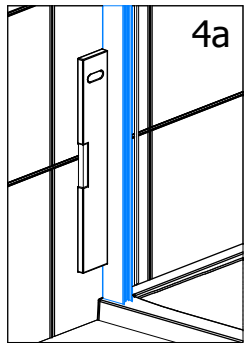

4a

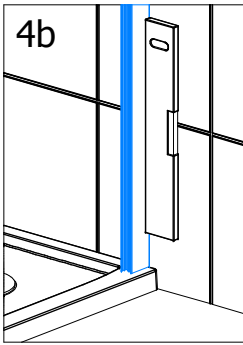
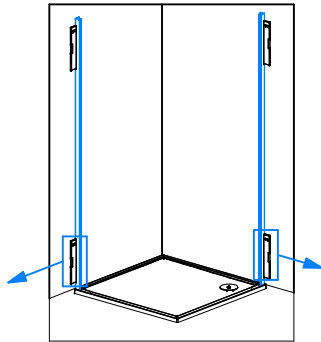

4b

L/R

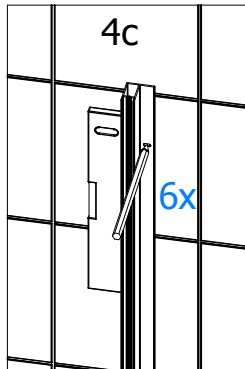

4c

6x

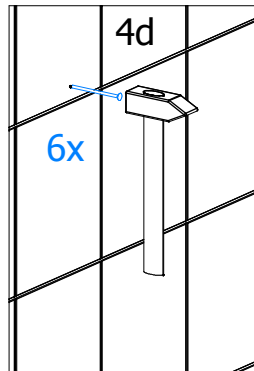
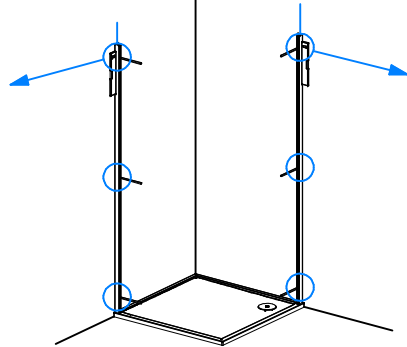

4d

6x

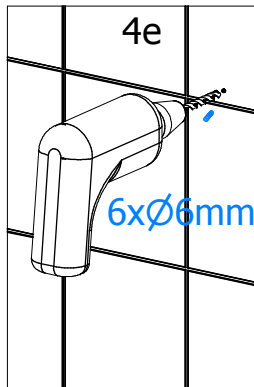

4e

6xØ6mm

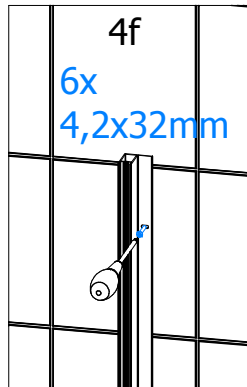

4f

6x
4,2x32mm

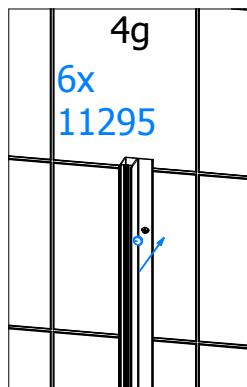

4g

6x
11295

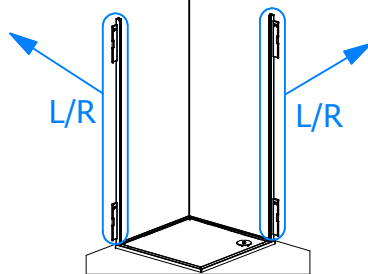

L/R

L/R

4.

9a

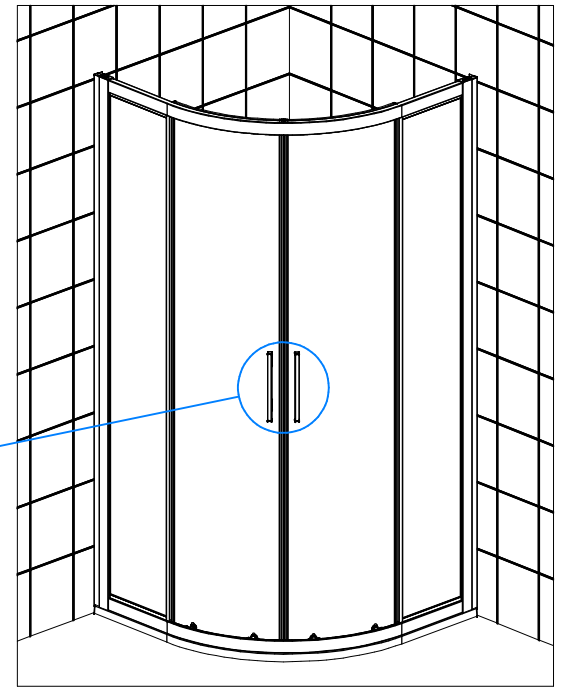

L/R

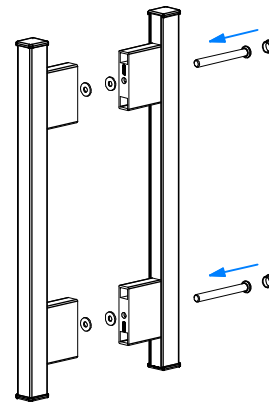

9.

